



stalgast
eksport gastronomiczny

DEKLARACJA ZGODNOŚCI

STALGAST RADOM sp. z o.o.

Staniewicka 5
03-310 Warszawa

Produkt:

Taborety, kuchnie gazowe

Model:

Wg. Załącznika nr. 1

Spełnia wymagania opisane w:

Dyrektywach :

2009/142/WE

- urządzenia spalające paliwo gazowe

2002/96/WE

- postępowanie ze zużytym sprzętem

2011/65/EU

- RoHs w sprawie ograniczenia stosowania niektórych niebezpiecznych substancji w sprzęcie elektrycznym i elektronicznym

Normach:

PN-EN 203-1+A1:2010

- Gastronomiczne urządzenia kuchenne na paliwo gazowe

- Część 1: Ogólne zasady bezpieczeństwa

PN-EN 203-2-1:2010

- Gastronomiczne urządzenia kuchenne na paliwo gazowe

Część 2-1: Wymagania szczególne .Palniki odkryte i palniki do woków

PN-EN 203-2-2

- Gastronomiczne urządzenia kuchenne na paliwo gazowe

Część 2-2:2010 Wymagania szczególne .Piekarniki

Oraz

Raport z badań Nr. 3178 A1 11

Certyfikat WE Nr1450CM0003 wydany przez Instytut Nafty i Gazu Kraków

Rozporządzeniu Nr 1935/2004 Parlamentu Europejskiego i Rady w sprawie materiałów i wyrobów przeznaczonych do kontaktu z żywnością oraz uchylającym Dyrektywy 80/590 i 89/109/EWG

Dwie ostatnie cyfry roku , w którym naniesiono oznaczenie **CE:10**

Deklarację wystawiono: Radom 04.01.2013

Wystawiający:

STANOWISKO Pełnomocnik d/s Jakości

PODPIS

Anna Piotrowska



E0003390WZ



Wpis do rejestru: XIII Wydział Gospodarczy Krajowego Rejestru Sądowego, KRS 0000384800, NIP 524-273-42-28, Kapitał zakładowy PLN 12.006.000,-



Stalgast Radom Sp. z o.o.

ul. Staniewicka 5 03-310 Warszawa tel.: 22 517 15 75

fax: 22 517 15 77



www.stalgast.com email: stalga@stalga.com



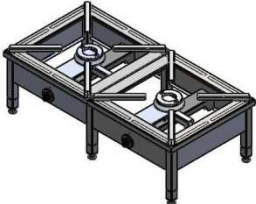
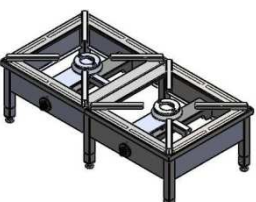

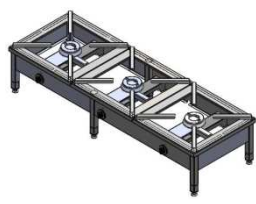



Załącznik nr 1 Wykaz – typoszereg kuchni

Rysunek poglądowy	Model	Moc grzewcza [kW]	Ilość palników	gaz	Nr katalogowy	Wymiary [szer. x gł. x wys]
	TG-1.03,5.1.00	3,5	1 x 3,5	G20		400 x 400 x 365
				G27		
				G30		
				G31		
	TG-1.05,0.1.00	5,0	1 x 5,0	G20		
				G27		
				G30		
				G31		
	TG-1.07,0.1.00	7,0	1 x 7,0	G20		
				G27		
				G30		
				G31		
	TG-1.05,0.2.00	5,0	1 x 5,0	G20		580 x 580 x 365
				G27		
				G30		
				G31		
	TG-1.07,0.2.00	7,0	1 x 7,0	G20		
				G27		
				G30		
				G31		
	TG-1.09,0.2.00	9,0	1 x 9,0	G20	773001	
				G27		
				G30	773003	
				G31		
 + misa podpalnikowa	TG-1.05,0.2.01	5,0	1 x 5,0	G20		580 x 580 x 365
				G27		
				G30		
				G31		
	TG-1.07,0.2.01	7,0	1 x 7,0	G20		
				G27		
				G30		
				G31		
	TG-1.09,0.2.01	9,0	1 x 9,0	G20		
				G27		
				G30		
				G31		

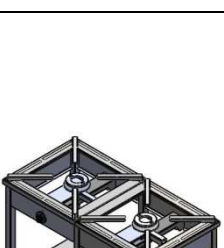
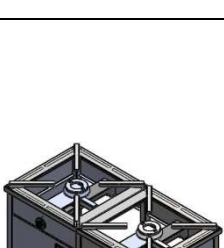
	TG-2.12,0.1.00	12,0	1 x 5,0 + 1 x 7,0	G20		1160 x 580 x 365
				G27		
				G30		
				G31		
	TG-2.14,0.1.00	14,0	2 x 7,0	G20		
				G27		
				G30		
				G31		
	TG-2.16,0.1.00	16,0	1 x 7,0 + 1 x 9,0	G20		
				G27		
				G30		
				G31		
TG-2.18,0.1.00	18,0	2 x 9,0	G20	773011		
			G27			
			G30	773013		
			G31			
 + misa podpalnikowa	TG-2.12,0.1.01	12,0	1 x 5,0 + 1 x 7,0	G20		1160 x 580 x 365
				G27		
				G30		
				G31		
	TG-2.14,0.1.01	14,0	2 x 7,0	G20		
				G27		
				G30		
				G31		
	TG-2.16,0.1.01	16,0	1 x 7,0 + 1 x 9,0	G20		
				G27		
				G30		
				G31		
	TG-2.18,0.1.01	18,0	2 x 9,0	G20		
				G27		
				G30		
				G31		

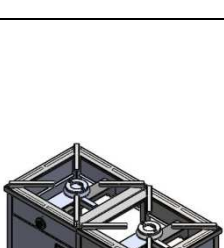
 + misa podpalnikowa	TG-3.19,0.1.00	19,0	1 x 5,0 + 2 x 7,0	G20		1740 x 580 x 365
				G27		
				G30		
				G31		
	TG-3.21,0.1.00	21,0	1 x 5,0 + 1 x 7,0 + 1 x 9,0	G20		
				G27		
				G30		
				G31		
	TG-3.23,0.1.00	23,0	2 x 7,0 + 1 x 9,0	G20		
				G27		
				G30		
				G31		
	TG-3.27,0.1.00	27,0	3 x 9,0	G20		
				G27		
				G30		
				G31		

 bez półki	KG-1.05,0.1.00	5,0	1 x 5,0	G20	580 x 580 x 850
				G27	
				G30	
	KG-1.07,0.1.00	7,0	1 x 7,0	G31	
				G20	
				G27	
	KG-1.09,0.1.00	9,0	1 x 9,0	G30	
				G31	
				G20	
 + misa podpalnikowa	KG-1.05,0.1.01	5,0	1 x 5,0	G27	580 x 580 x 850
				G30	
				G31	
	KG-1.07,0.1.01	7,0	1 x 7,0	G20	
				G27	
				G30	
	KG-1.09,0.1.01	9,0	1 x 9,0	G31	
				G20	
				G27	
 + misa podpalnikowa + szafka	KG-1.05,0.1.02	5,0	1 x 5,0	G30	580 x 580 x 850
				G31	
				G20	
	KG-1.07,0.1.02	7,0	1 x 7,0	G27	
				G30	
				G31	
	KG-1.09,0.1.02	9,0	1 x 9,0	G20	
				G27	
				G30	
				G31	

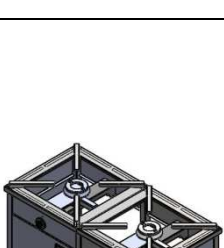
 <p>bez półki + misa podpalnikowa</p>	KG-2.12,0.1.00	12,0	1 x 5,0 + 1 x 7,0	G20		1160 x 580 x 850	
				G27			
				G30			
				G31			
 <p>+ misa podpalnikowa</p>	KG-2.14,0.1.00	14,0	2 x 7,0	G20		1160 x 580 x 850	
				G27			
				G30			
				G31			
 <p>+misa podpalnikowa + szafka</p>	KG-2.16,0.1.00	16,0	1 x 7,0 + 1 x 9,0	G20		1160 x 580 x 850	
				G27			
				G30			
				G31			
 <p>+ misa podpalnikowa</p>	KG-2.18,0.1.00	18,0	2 x 9,0	G20		1160 x 580 x 850	
				G27			
				G30			
				G31			
 <p>+misa podpalnikowa + szafka</p>	KG-2.12,0.1.01	12,0	1 x 5,0 + 1 x 7,0	G20		1160 x 580 x 850	
				G27			
				G30			
				G31			
 <p>+ misa podpalnikowa</p>	KG-2.14,0.1.01	14,0	2 x 7,0	G20		1160 x 580 x 850	
				G27			
				G30			
				G31			
 <p>+misa podpalnikowa + szafka</p>	KG-2.16,0.1.01	16,0	1 x 7,0 + 1 x 9,0	G20		1160 x 580 x 850	
				G27			
				G30			
				G31			
 <p>+misa podpalnikowa + szafka</p>	KG-2.18,0.1.01	18,0	2 x 9,0	G20		1160 x 580 x 850	
				G27			
				G30			
				G31			
 <p>+misa podpalnikowa + szafka</p>	KG-2.12,0.1.02	12,0	1 x 5,0 + 1 x 7,0	G20		1160 x 580 x 850	
				G27			
				G30			
				G31			
 <p>+ misa podpalnikowa</p>	KG-2.14,0.1.02	14,0	2 x 7,0	G20		1160 x 580 x 850	
				G27			
				G30			
				G31			
 <p>+misa podpalnikowa + szafka</p>	KG-2.16,0.1.02	16,0	1 x 7,0 + 1 x 9,0	G20		1160 x 580 x 850	
				G27			
				G30			
				G31			
 <p>+misa podpalnikowa + szafka</p>	KG-2.18,0.1.02	18,0	2 x 9,0	G20		1160 x 580 x 850	
				G27			
				G30			
				G31			

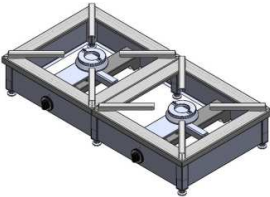
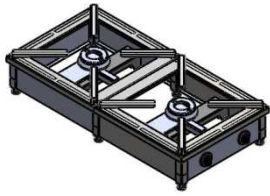
 <p>+ misa podpalnikowa + sterowanie na dłuższym boku</p>	KG-2.08,5.2.01	8,5	1 x 5,0 + 1 x 7,0	G20		700 x 400 x 200
				G27		
				G30		
				G31		
	KG-2.10,5.2.01	10,5	1 x 3,5+1 x 7	G20		
				G27		
				G30		
				G31		
	KG-2.16,0.2.00	16,0	1 x 7,0 + 1 x 9,0	G20		
				G27		
				G30		
				G31		
KG-2.18,0.2.00	18,0	2 x 9,0	G20			
			G27			
			G30			
			G31			
 <p>+ misa podpalnikowa + kominek + sterowanie na krótszym boku</p>	KG-2.08,5.2.01	8,5	1 x 5,0 + 1 x 7,0	G20	970511	700 x 400 x 200
				G27		
				G30	970513	
				G31		
	KG-2.10,5.2.01	10,5	1 x 3,5+1 x 7	G20	970521	
				G27		
				G30	970523	
				G31		
	KG-2.16,0.2.01	16,0	1 x 7,0 + 1 x 9,0	G20		
				G27		
				G30		
				G31		
KG-2.18,0.2.01	18,0	2 x 9,0	G20			
			G27			
			G30			
			G31			

 <p>bez półki</p>	KG-3.19,0.1.00	19,0	1 x 5,0 + 2 x 7,0	G20		1740 x 580 x 850
				G27		
				G30		
				G31		
	KG-3.21,0.1.00	21,0	3 x 7,0	G20		
				G27		
				G30		
				G31		
	KG-3.22,0.1.00	22,0	1 x 5,0 + 1 x 7,0 + 1 x 9,0	G20		
				G27		
				G30		
				G31		
KG-3.23,0.1.00	23,0	2 x 7,0 + 1 x 9,0	G20			
			G27			
			G30			
			G31			

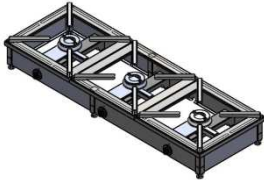

	KG-3.27,0.1.00	27,0	3 x 9,0	G20		
				G27		
				G30		
				G31		

 <p>+ misa podpalnikowa</p>	KG-3.19,0.1.01	19,0	1 x 5,0 + 2 x 7,0	G20		1740 x 580 x 850
				G27		
				G30		
				G31		
	KG-3.21,0.1.01	21,0	3 x 7,0	G20		
				G27		
				G30		
				G31		
	KG-3.22,0.1.01	22,0	1 x 5,0 + 1 x 7,0 + 1 x 9,0	G20		
				G27		
				G30		
				G31		
	KG-3.23,0.1.01	23,0	2 x 7,0 + 1 x 9,0	G20		
				G27		
				G30		
				G31		
KG-3.27,0.1.01	27,0	3 x 9,0	G20			
			G27			
			G30			
			G31			

 <p>+ misa podpalnikowa</p>	KG-3.19,0.2.00	19,0	1 x 5,0 + 2 x 7,0	G20		1740 x 580 x 200
				G27		
				G30		
				G31		
	KG-3.21,0.2.00	21,0	3 x 7,0	G20		
				G27		
				G30		
				G31		
	KG-3.22,0.2.00	22,0	1 x 5,0 + 1 x 7,0 + 1 x 9,0	G20		
				G27		
				G30		
				G31		
	KG-3.23,0.2.00	23,0	2 x 7,0 + 1 x 9,0	G20		
				G27		
				G30		
				G31		
KG-3.27,0.2.00	27,0	3 x 9,0	G20			
			G27			
			G30			
			G31			

	KG-4.20,5.1.00	20,5	1 x 3,5 + 2 x 5,0 + 1 x 7,0	G20		2320 x 580 x 850
				G27		
				G30		
				G31		
	KG-4.22,5.1.00	22,5	1 x 3,5 + 1 x 5,0 + 2 x 7,0	G20		
				G27		
			G30			

	KG-4.24,0.1.00	24,0	2 x 5,0 + 2 x 7,0	G31	
				G20	
				G27	
				G30	
	KG-4.24,5.1.00	24,5	1 x 3,5 + 1 x 5,0 + 1 x 7,0 + 1 x 9,0	G31	
				G20	
				G27	
				G30	
				G31	



 <p>bez pólki</p>	KG-4.20,5.2.00	20,5	1 x 3,5 + 2 x 5,0 + 1 x 7,0	G20		900 x 900 x 850
				G27		
				G30		
				G31		
	KG-4.22,5.2.00	22,5	1 x 3,5 + 1 x 5,0 + 2 x 7,0	G20		
				G27		
				G30		
				G31		
	KG-4.24,0.2.00	24,0	2 x 5,0 + 2 x 7,0	G20		
				G27		
				G30		
				G31		
KG-4.24,5.2.00	24,5	1 x 3,5 + 1 x 5,0 + 1 x 7,0 + 1 x 9,0	G20			
			G27			
			G30			
			G31			
	KG-4.20,5.2.01	20,5	1 x 3,5 + 2 x 5,0 + 1 x 7,0	G20	999511	900 x 900 x 850
				G27		
				G30	999513	
				G31		
	KG-4.22,5.2.01	22,5	1 x 3,5 + 1 x 5,0 + 2 x 7,0	G20	999521	
				G27		
				G30	999523	
				G31		
	KG-4.24,0.2.01	24,0	2 x 5,0 + 2 x 7,0	G20	999531	
				G27		
				G30	999533	
				G31		
KG-4.24,5.2.01	24,5	1 x 3,5 + 1 x 5,0 + 1 x 7,0 + 1 x 9,0	G20	999541		
			G27			
			G30	999543		
			G31			
 <p>+ kominek</p>	KG-4.20,5.2.02	20,5	1 x 3,5 + 2 x 5,0 + 1 x 7,0	G20		900 x 900 x 850
				G27		
				G30		
				G31		
	KG-4.22,5.2.02	22,5	1 x 3,5 + 1 x 5,0 + 2 x 7,0	G20		
				G27		
				G30		
				G31		
	KG-4.24,0.2.02	24,0	2 x 5,0 + 2 x 7,0	G20		
				G27		

				G30		
				G31		
	KG-4.24,5.2.02	24,5	1 x 3,5 + 1 x 5,0 + 1 x 7,0 + 1 x 9,0	G20		
				G27		
				G30		
				G31		

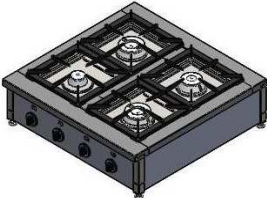
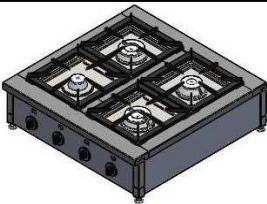
	KG-4.20,5.2.03	20,5	1 x 3,5 + 2 x 5,0 + 1 x 7,0	G20	900 x 900 x 850
				G27	
				G30	
				G31	
	KG-4.22,5.2.03	22,5	1 x 3,5+1 x 5,0 + 2 x 7,0	G20	
				G27	
				G30	
				G31	
	KG-4.24,0.2.03	24,0	2 x 5,0 + 2 x 7,0	G20	
				G27	
				G30	
				G31	
	KG-4.24,5.2.03	24,5	1 x 3,5 + 1 x 5,0 + 1 x 7,0 + 1 x 9,0	G20	
				G27	
				G30	
				G31	

	KG-4.20,5.3.00	20,5	1 x 3,5 + 2 x 5,0 + 1 x 7,0	G20	900 x 900 x 270
				G27	
				G30	
				G31	
	KG-4.22,5.3.00	22,5	1 x 3,5+1 x 5,0 + 2 x 7,0	G20	
				G27	
				G30	
				G31	
	KG-4.24,0.3.00	24,0	2 x 5,0 + 2 x 7,0	G20	
				G27	
				G30	
				G31	
	KG-4.24,5.3.00	24,5	1 x 3,5 + 1 x 5,0 + 1 x 7,0 + 1 x 9,0	G20	
				G27	
				G30	
				G31	
 + kominek	KG-4.20,5.3.01	20,5	1 x 3,5 + 2 x 5,0 + 1 x 7,0	G20	900 x 900 x 270
				G27	
				G30	
				G31	
	KG-4.22,5.3.01	22,5	1 x 3,5+1 x 5,0 + 2 x 7,0	G20	
				G27	
				G30	
				G31	
	KG-4.24,0.3.01	24,0	2 x 5,0 + 2 x 7,0	G20	
				G27	
				G30	
				G31	
	KG-4.24,5.3.01	24,5	1 x 3,5 + 1 x 5,0 + 1 x 7,0 + 1 x 9,0	G20	
				G27	
				G30	
				G31	

				G31		
--	--	--	--	-----	--	--



 <p>bez pólki</p>	KG-4.20,5.4.00	20,5	1 x 3,5 + 2 x 5,0 + 1 x 7,0	G20	800 x 750 x 850
				G27	
				G30	
				G31	
	KG-4.22,5.4.00	22,5	1 x 3,5+1 x 5,0 + 2 x 7,0	G20	
				G27	
				G30	
				G31	
	KG-4.24,0.4.00	24,0	2 x 5,0 + 2 x 7,0	G20	
				G27	
				G30	
				G31	
KG-4.24,5.4.00	24,5	1 x 3,5 + 1 x 5,0 + 1 x 7,0 + 1 x 9,0	G20		
			G27		
			G30		
			G31		
	KG-4.20,5.4.01	20,5	1 x 3,5 + 2 x 5,0 + 1 x 7,0	G20	800 x 750 x 850
				G27	
				G30	
				G31	
	KG-4.22,5.4.01	22,5	1 x 3,5+1 x 5,0 + 2 x 7,0	G20	
				G27	
				G30	
				G31	
	KG-4.24,0.4.01	24,0	2 x 5,0 + 2 x 7,0	G20	
				G27	
				G30	
				G31	
KG-4.24,5.4.01	24,5	1 x 3,5 + 1 x 5,0 + 1 x 7,0 + 1 x 9,0	G20		
			G27		
			G30		
			G31		
 <p>+kominek</p>	KG-4.20,5.4.02	20,5	1 x 3,5 + 2 x 5,0 + 1 x 7,0	G20	800 x 750 x 850
				G27	
				G30	
				G31	
	KG-4.22,5.4.02	22,5	1 x 3,5+1 x 5,0 + 2 x 7,0	G20	
				G27	
				G30	
				G31	
	KG-4.24,0.4.02	24,0	2 x 5,0 + 2 x 7,0	G20	
				G27	
				G30	
				G31	

				G31		
	KG-4.24,5.4.02	24,5	1 x 3,5 + 1 x 5,0 + 1 x 7,0 + 1 x 9,0	G20		
				G27		
				G30		
				G31		

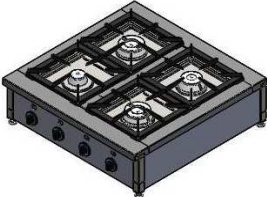
	KG-4.20,5.4.03	20,5	1 x 3,5 + 2 x 5,0 + 1 x 7,0	G20	800 x 750 x 850
				G27	
				G30	
				G31	
	KG-4.22,5.4.03	22,5	1 x 3,5+1 x 5,0 + 2 x 7,0	G20	
				G27	
				G30	
				G31	
	KG-4.24,0.4.03	24,0	2 x 5,0 + 2 x 7,0	G20	
				G27	
				G30	
				G31	
KG-4.24,5.4.03	24,5	1 x 3,5 + 1 x 5,0 + 1 x 7,0 + 1 x 9,0	G20		
			G30		
			G27		
			G31		

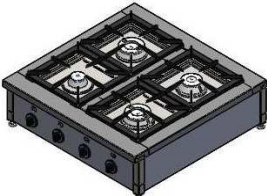



	KG-4.20,5.5.00	20,5	1 x 3,5 + 2 x 5,0 + 1 x 7,0	G20	800 x 750 x 270
				G27	
				G30	
				G31	
	KG-4.22,5.5.00	22,5	1 x 3,5+1 x 5,0 + 2 x 7,0	G20	
				G27	
				G30	
				G31	
	KG-4.24,0.5.00	24,0	2 x 5,0 + 2 x 7,0	G20	
				G27	
				G30	
				G31	
KG-4.24,5.5.00	24,5	1 x 3,5 + 1 x 5,0 + 1 x 7,0 + 1 x 9,0	G20		
			G27		
			G30		
			G31		

 + kominek	KG-4.20,5.5.01	20,5	1 x 3,5 + 2 x 5,0 + 1 x 7,0	G20	800 x 750 x 270
				G27	
				G30	
				G31	
	KG-4.22,5.5.01	22,5	1 x 3,5+1 x 5,0 + 2 x 7,0	G20	
				G27	
				G30	
				G31	
	KG-4.24,0.5.01	24,0	2 x 5,0 + 2 x 7,0	G20	
				G27	
				G30	
				G31	
KG-4.24,5.5.01	24,5	1 x 3,5 + 1 x 5,0 + 1 x 7,0 + 1 x 9,0	G20		
			G27		
			G30		
			G31		





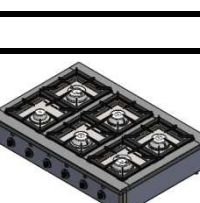

 <p>bez pólki</p>	KG-4.20,5.6.00	20,5	1 x 3,5 + 2 x 5,0 + 1 x 7,0	G20		800 x 700 x 850
				G27		
				G30		
				G31		
	KG-4.22,5.6.00	22,5	1 x 3,5+1 x 5,0 + 2 x 7,0	G20		
				G27		
				G30		
				G31		
	KG-4.24,0.6.00	24,0	2 x 5,0 + 2 x 7,0	G20		
				G27		
				G30		
				G31		
KG-4.24,5.6.00	24,5	1 x 3,5 + 1 x 5,0 + 1 x 7,0 + 1 x 9,0	G20			
			G27			
			G30			
			G31			
	KG-4.20,5.6.01	20,5	1 x 3,5 + 2 x 5,0 + 1 x 7,0	G20	979511	800 x 700 x 850
				G27		
				G30	979513	
				G31		
	KG-4.22,5.6.01	22,5	1 x 3,5+1 x 5,0 + 2 x 7,0	G20	979521	
				G27		
				G30	979523	
				G31		
	KG-4.24,0.6.01	24,0	2 x 5,0 + 2 x 7,0	G20	979531	
				G27		
				G30	979533	
				G31		
KG-4.24,5.6.01	24,5	1 x 3,5 + 1 x 5,0 + 1 x 7,0 + 1 x 9,0	G20	979541		
			G27			
			G30	979543		
			G31			
 <p>+kominek</p>	KG-4.20,5.6.02	20,5	1 x 3,5 + 2 x 5,0 + 1 x 7,0	G20		800 x 700 x 850
				G27		
				G30		
				G31		
	KG-4.22,5.6.02	22,5	1 x 3,5+1 x 5,0 + 2 x 7,0	G20		
				G27		
				G30		
				G31		
	KG-4.24,0.6.02	24,0	2 x 5,0 + 2 x 7,0	G20		
				G27		
				G30		
				G31		
KG-4.24,5.6.02	24,5	1 x 3,5 + 1 x 5,0 + 1 x 7,0 + 1 x 9,0	G20			
			G27			
			G30			
			G31			

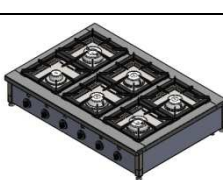
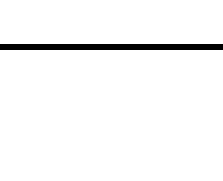

	KG-4.20,5.6.03	20,5	1 x 3,5 + 2 x 5,0 + 1 x 7,0	G20	800 x 700 x 850
				G27	
				G30	
				G31	
	KG-4.22,5.6.03	22,5	1 x 3,5+1 x 5,0 + 2 x 7,0	G20	
				G27	
				G30	
				G31	
	KG-4.24,0.6.03	24,0	2 x 5,0 + 2 x 7,0	G20	
				G27	
				G30	
				G31	
	KG-4.24,5.6.03	24,5	1 x 3,5 + 1 x 5,0 + 1 x 7,0 + 1 x 9,0	G20	
				G27	
				G30	
				G31	

	KG-4.20,5.7.00	20,5	1 x 3,5 + 2 x 5,0 + 1 x 7,0	G20	800 x 700 x 270	
				G27		
				G30		
				G31		
	KG-4.22,5.7.00	22,5	1 x 3,5+1 x 5,0 + 2 x 7,0	G20		
				G27		
				G30		
				G31		
	KG-4.24,0.7.00	24,0	2 x 5,0 + 2 x 7,0	G20		
				G27		
				G30		
				G31		
	KG-4.24,5.7.00	24,5	1 x 3,5 + 1 x 5,0 + 1 x 7,0 + 1 x 9,0	G20		
				G27		
				G30		
				G31		
 + kominek	KG-4.20,5.7.01	20,5	1 x 3,5 + 2 x 5,0 + 1 x 7,0	G20	970611	800 x 700 x 270
				G27		
				G30	970612	
				G31		
	KG-4.22,5.7.01	22,5	1 x 3,5+1 x 5,0 + 2 x 7,0	G20	970621	
				G27		
				G30	970623	
				G31		
	KG-4.24,0.7.01	24,0	2 x 5,0 + 2 x 7,0	G20	970631	
				G27		
				G30	970633	
				G31		
	KG-4.24,5.7.01	24,5	1 x 3,5 + 1 x 5,0 + 1 x 7,0 + 1 x 9,0	G20	970641	
				G27		
				G30	970643	
				G31		





 bez pólki	KG-6.32,5.1.00	32,5	1 x 3,5 + 3 x 5,0 + 2 x 7,0	G20		1300 x 900 x 850
				G27		
				G30		
				G31		
 bez pólki	KG-6.36,5.1.00	36,5	1 x 3,5 + 2 x 5,0 + 2 x 7,0 + 1 x 9,0	G20		
				G27		
				G30		
				G31		
 + kominek	KG-6.32,5.1.01	32,5	1 x 3,5 + 3 x 5,0 + 2 x 7,0	G20	999611	1300 x 900 x 850
				G27		
				G30	999613	
				G31		
	KG-6.36,5.1.01	36,5	1 x 3,5 + 2 x 5,0 + 2 x 7,0 + 1 x 9,0	G20	999621	
				G27		
				G30	999623	
				G31		
 + kominek	KG-6.32,5.1.02	32,5	1 x 3,5 + 3 x 5,0 + 2 x 7,0	G20		1300 x 900 x 850
				G27		
				G30		
				G31		
	KG-6.36,5.1.02	36,5	1 x 3,5 + 2 x 5,0 + 2 x 7,0 + 1 x 9,0	G20		
				G27		
				G30		
				G31		
 + kominek	KG-6.32,5.1.03	32,5	1 x 3,5 + 3 x 5,0 + 2 x 7,0	G20		1300 x 900 x 850
				G27		
				G30		
				G31		
	KG-6.36,5.1.03	36,5	1 x 3,5 + 2 x 5,0 + 2 x 7,0 + 1 x 9,0	G20		
				G27		
				G30		
				G31		



 bez pólki	KG-6.32,5.2.00	32,5	1 x 3,5 + 3 x 5,0 + 2 x 7,0	G20		1300 x 900 x 270
				G27		
				G30		
				G31		
 bez pólki	KG-6.36,5.2.00	36,5	1 x 3,5 + 2 x 5,0 + 2 x 7,0 + 1 x 9,0	G20		
				G27		
				G30		
				G31		
 + kominek	KG-6.32,5.2.01	32,5	1 x 3,5 + 3 x 5,0 + 2 x 7,0	G20	970711	1300 x 900 x 270
				G27		
				G30	970713	
				G31		
	KG-6.36,5.2.01	36,5	1 x 3,5 + 2 x 5,0 + 2 x 7,0 + 1 x 9,0	G20	970721	
				G27		
				G30	970723	
				G31		



 bez pólki	KG-6.32,5.3.00	32,5	1 x 3,5 + 3 x 5,0 + 2 x 7,0	G20		1200 x750 x 850
				G27		
				G30		
				G31		
 bez pólki	KG-6.36,5.3.00	36,5	1 x 3,5 + 2 x 5,0 + 2 x 7,0 + 1 x 9,0	G20		
				G27		
				G30		
				G31		
 + kominek	KG-6.32,5.3.01	32,5	1 x 3,5 + 3 x 5,0 + 2 x 7,0	G20		1200 x750 x 850
				G27		
				G30		
				G31		
 + kominek	KG-6.36,5.3.01	36,5	1 x 3,5 + 2 x 5,0 + 2 x 7,0 + 1 x 9,0	G20		
				G27		
				G30		
				G31		
 + kominek	KG-6.32,5.3.02	32,5	1 x 3,5 + 3 x 5,0 + 2 x 7,0	G20		1200 x750 x 850
				G27		
				G30		
				G31		
 + kominek	KG-6.36,5.3.02	36,5	1 x 3,5 + 2 x 5,0 + 2 x 7,0 + 1 x 9,0	G20		
				G27		
				G30		
				G31		
 + kominek	KG-6.32,5.3.03	32,5	1 x 3,5 + 3 x 5,0 + 2 x 7,0	G20		1200 x750 x 850
				G27		
				G30		
				G31		
 + kominek	KG-6.36,5.3.03	36,5	1 x 3,5 + 2 x 5,0 + 2 x 7,0 + 1 x 9,0	G20		
				G27		
				G30		
				G31		

	KG-6.32,5.4.00	32,5	1 x 3,5 + 3 x 5,0 + 2 x 7,0	G20		1200 x750 x 270
				G27		
				G30		
				G31		
	KG-6.36,5.4.00	36,5	1 x 3,5 + 2 x 5,0 + 2 x 7,0 + 1 x 9,0	G20		
				G27		
				G30		
				G31		



 + kominek	KG-6.32,5.4.01	32,5	1 x 3,5 + 3 x 5,0 + 2 x 7,0	G00		1200 x750 x 270
				G27		
				G30		
				G31		
	KG-6.36,5.4.01	36,5	1 x 3,5 + 2 x 5,0 + 2 x 7,0 + 1 x 9,0	G20		
				G27		
				G30		
				G31		

 bez p�tki	KG-6.32,5.5.00	32,5	1 x 3,5 + 3 x 5,0 + 2 x 7,0	G20		1200 x700 x 850
				G27		
				G30		
				G31		
	KG-6.36,5.5.00	36,5	1 x 3,5 + 2 x 5,0 + 2 x 7,0 + 1 x 9,0	G20		
				G27		
				G30		
				G31		
	KG-6.32,5.5.01	32,5	1 x 3,5 + 3 x 5,0 + 2 x 7,0	G20	979611	1200 x700 x 850
				G27		
				G30	979613	
				G31		
	KG-6.36,5.5.01	36,5	1 x 3,5 + 2 x 5,0 + 2 x 7,0 + 1 x 9,0	G20	979621	
				G27		
				G30	979623	
				G31		
 + kominek	KG-6.32,5.5.02	32,5	1 x 3,5 + 3 x 5,0 + 2 x 7,0	G20		1200 x700 x 850
				G27		
				G30		
				G31		
	KG-6.36,5.5.02	36,5	1 x 3,5 + 2 x 5,0 + 2 x 7,0 + 1 x 9,0	G20		
				G27		
				G30		
				G31		
	KG-6.32,5.5.03	32,5	1 x 3,5 + 3 x 5,0 + 2 x 7,0	G20		1200 x700 x 850
				G27		
				G30		
				G31		
	KG-6.36,5.5.03	36,5	1 x 3,5 + 2 x 5,0 + 2 x 7,0 + 1 x 9,0	G20		
				G27		
				G30		
				G31		



	KG-6.32,5.6.00	32,5	1 x 3,5 + 3 x 5,0 + 2 x 7,0	G20		1200 x 700 x 270
				G27		
				G30		
				G31		
	KG-6.36,5.6.00	36,5	1 x 3,5 + 2 x 5,0 + 2 x 7,0 + 1 x 9,0	G20		
				G27		
				G30		
				G31		
 + kominek	KG-6.32,5.6.01	32,5	1 x 3,5 + 3 x 5,0 + 2 x 7,0	G20	970711	1200 x 700 x 270
				G27		
				G30	970713	
				G31		
	KG-6.36,5.6.01	36,5	1 x 3,5 + 2 x 5,0 + 2 x 7,0 + 1 x 9,0	G20	970721	
				G27		
				G30	970723	
				G31		

 bez półki	KG-8.39,5.1.00	39,5	3 x 3,5 + 3 x 5,0 + 2 x 7,0	G20		1700x900x850
				G27		
				G30		
				G31		
	KG-8.41,5.1.00	41,5	3 x 3,5 + 3 x 5,0 + 1 x 7,0 + 1 x 9,0	G20		
				G27		
				G30		
				G31		
	KG-8.45,0.1.00	45,0	2 x 3,5 + 3 x 5,0 + 2 x 7,0 + 1 x 9,0	G20		
G27						
G30						
G31						
	KG-8.39,5.1.01	39,5	3 x 3,5 + 3 x 5,0 + 2 x 7,0	G20		1700x900x850
				G27		
				G30		
				G31		
	KG-8.41,5.1.01	41,5	3 x 3,5 + 3 x 5,0 + 1 x 7,0 + 1 x 9,0	G20		
				G27		
				G30		
				G31		
	KG-8.45,0.1.01	45,0	2 x 3,5 + 3 x 5,0 + 2 x 7,0 + 1 x 9,0	G20		
G27						
G30						
G31						
 + kominek	KG-8.39,5.1.02	39,5	3 x 3,5 + 3 x 5,0 + 2 x 7,0	G20		1700x900x850
				G27		
				G30		
				G31		
	KG-8.41,5.1.02	41,5	3 x 3,5 + 3 x 5,0 + 1 x 7,0 + 1 x 9,0	G20		
				G27		
				G30		
				G31		
	KG-8.45,0.1.02	45,0	2 x 3,5 + 3 x 5,0 + 2 x 7,0 + 1 x 9,0	G20		
G27						
G30						

	KG-8.39,5.1.03	39,5	3 x 3,5 + 3 x 5,0 + 2 x 7,0	G31	1700x900x850
				G20	
				G27	
				G30	
	KG-8.41,5.1.03	41,5	3 x 3,5 + 3 x 5,0 + 1 x 7,0 + 1 x 9,0	G31	
				G20	
				G27	
				G30	
	KG-8.45,0.1.03	45,0	2 x 3,5 + 3 x 5,0 + 2 x 7,0 + 1 x 9,0	G31	
				G20	
				G27	
				G30	

 bez półki	KG-8.39,5.2.00	39,5	3 x 3,5 + 3 x 5,0 + 2 x 7,0	G20	1550x750x850
				G27	
				G30	
				G31	
	KG-8.41,5.2.00	41,5	3 x 3,5 + 3 x 5,0 + 1 x 7,0 + 1 x 9,0	G20	
				G27	
				G30	
				G31	
	KG-8.45,0.2.00	45,0	2 x 3,5 + 3 x 5,0 + 2 x 7,0 + 1 x 9,0	G20	
G27					
G30					
G31					
	KG-8.39,5.2.01	39,5	3 x 3,5 + 3 x 5,0 + 2 x 7,0	G20	1550x750x850
				G27	
				G30	
				G31	
	KG-8.41,5.2.01	41,5	3 x 3,5 + 3 x 5,0 + 1 x 7,0 + 1 x 9,0	G20	
				G27	
				G30	
				G31	
	KG-8.45,0.2.01	45,0	2 x 3,5 + 3 x 5,0 + 2 x 7,0 + 1 x 9,0	G20	
G27					
G30					
G31					
	KG-8.39,5.2.02	39,5	3 x 3,5 + 3 x 5,0 + 2 x 7,0	G20	1550x750x850
				G27	
				G30	
				G31	
	KG-8.41,5.2.02	41,5	3 x 3,5 + 3 x 5,0 + 1 x 7,0 + 1 x 9,0	G20	
				G27	
G30					

+ kominek	KG-8.45,0.2.02	45,0	2 x 3,5 + 3 x 5,0 + 2 x 7,0 + 1 x 9,0	G31		1550x750x850
				G20		
				G27		
				G30		
				G31		
	KG-8.39,5.2.03	39,5	3 x 3,5 + 3 x 5,0 + 2 x 7,0	G20		
				G27		
				G30		
				G31		
	KG-8.41,5.2.03	41,5	3 x 3,5 + 3 x 5,0 + 1 x 7,0 + 1 x 9,0	G20		
				G27		
				G30		
				G31		
	KG-8.45,0.2.03	45,0	2 x 3,5 + 3 x 5,0 + 2 x 7,0 + 1 x 9,0	G20		
				G27		
				G30		
				G31		

 bez pólki	KG-8.39,5.3.00	39,5	3 x 3,5 + 3 x 5,0 + 2 x 7,0	G20		
				G27		
				G30		
				G31		
	KG-8.41,5.3.00	41,5	3 x 3,5 + 3 x 5,0 + 1 x 7,0 + 1 x 9,0	G20		
				G27		
				G30		
				G31		
	KG-8.45,0.3.00	45,0	2 x 3,5 + 3 x 5,0 + 2 x 7,0 + 1 x 9,0	G20		
				G27		
				G30		
				G31		
	KG-8.39,5.3.01	39,5	3 x 3,5 + 3 x 5,0 + 2 x 7,0	G20		
				G27		
				G30		
				G31		
	KG-8.41,5.3.01	41,5	3 x 3,5 + 3 x 5,0 + 1 x 7,0 + 1 x 9,0	G20		
				G27		
				G30		
				G31		
	KG-8.45,0.3.01	45,0	2 x 3,5 + 3 x 5,0 + 2 x 7,0 + 1 x 9,0	G20		
				G27		
				G30		
				G31		
	KG-8.39,5.3.02	39,5	3 x 3,5 + 3 x 5,0 + 2 x 7,0	G20		
				G27		

+ kominek				G30		
				G31		
	KG-8.41,5.3.02	41,5	$3 \times 3,5 + 3 \times 5,0 + 1 \times 7,0 + 1 \times 9,0$	G20		
				G27		
				G30		
				G31		
	KG-8.45,0.3.02	45,0	$2 \times 3,5 + 3 \times 5,0 + 2 \times 7,0 + 1 \times 9,0$	G20		
				G27		
			G30			
			G31			
	KG-8.39,5.3.03	39,5	$3 \times 3,5 + 3 \times 5,0 + 2 \times 7,0$	G20		
				G27		
				G30		
				G31		
	KG-8.41,5.3.03	41,5	$3 \times 3,5 + 3 \times 5,0 + 1 \times 7,0 + 1 \times 9,0$	G20		
				G27		
				G30		
				G31		
	KG-8.45,0.3.03	45,0	$2 \times 3,5 + 3 \times 5,0 + 2 \times 7,0 + 1 \times 9,0$	G20		
				G27		
				G30		
				G31		

Załącznik 1. Typoszereg kuchni z piekarnikiem gazowym

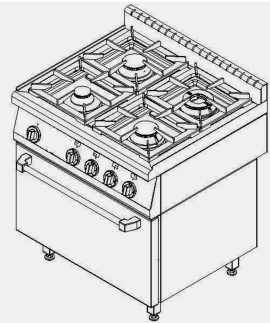
Rysunek poglądowy	Model	Moc grzewcza [kW]	Ilość x moc (kW) palników	gaz	Nr katalogowy	Wymiary [szer. x gł. x wys]
	KPGG-4.25,5.3.01	25,5	1 x 3,5 + 2 x 5,0 + 1 x 7,0 Piekarnik 5,0	G20		900 x 900 x 850 Piekarnik 530x650 (GN2/1)
				G27		
				G30		
				G31		
	KPGG - 4.27,5.3.01	27,5	1 x 3,5 + 1 x 5,0 + 2 x 7,0 Piekarnik 5,0	G20		
				G27		
				G30		
				G31		
	KPGG - 4.29,0.3.01	29,0	2 x 5,0 + 2 x 7,0 Piekarnik 5,0	G20		
				G27		
				G30		
				G31		
	KPGG - 4.29,5.3.01	29,5	1 x 3,5 + 1 x 5,0 + 1 x 7,0 + 1 x 9,0 Piekarnik 5,0	G20		
				G27		
				G30		
				G31		

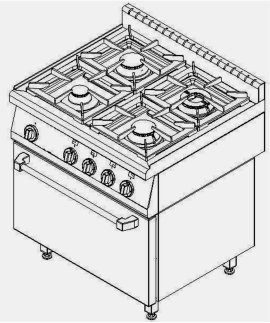
	KPGG - 4.25,5.5.01	25,5	1 x 3,5 + 2 x 5,0 + 1 x 7,0 Piekarnik 5,0	G20		800 x 750 x 850 Piekarnik 530x650 (GN2/1)
				G27		
				G30		
				G31		
	KPGG - 4.27,5.5.01	27,5	1 x 3,5 + 1 x 5,0 + 2 x 7,0 Piekarnik 5,0	G20		
				G27		
				G30		
				G31		
	KPGG - 4.29,0.5.01	29,0	2 x 5,0 + 2 x 7,0 Piekarnik 5,0	G20		
				G27		
				G30		
				G31		
	KPGG - 4.29,5.5.01	29,5	1 x 3,5 + 1 x 5,0 + 1 x 7,0 + 1 x 9,0 Piekarnik 5,0	G20		
				G27		
				G30		
				G31		

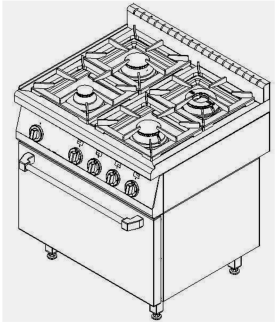
	KGPG - 4.25,5.7.01	25,5	1 x 3,5 + 2 x 5,0 + 1 x 7,0 Piekarnik 5,0	G20	971011	800 x 700 x 850 Piekarnik 530x650 (GN2/1)
				G27		
				G30	9710013	
				G31		
	KGPG - 4.27,5.7.01	27,5	1 x 3,5+1 x 5,0 + 2 x 7,0 Piekarnik 5,0	G20	971021	
				G27		
				G30	971023	
	KGPG - 4.29,0.7.01	29,0	2 x 5,0 + 2 x 7,0 Piekarnik 5,0	G20	971031	
				G27		
				G30	971033	
	KGPG - 4.29,5.7.01	29,5	1 x 3,5 + 1 x 5,0 + 1 x 7,0 + 1 x 9,0 Piekarnik 5,0	G20		
				G27		
G30						
G31						

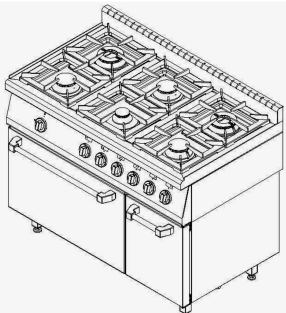
	KGPG - 6.37,5.2.01	37,5	1 x 3,5 + 3 x 5,0 + 2 x 7,0 Piekarnik 5,0	G20	971111	1200 x 900 x 850 Piekarnik 530x650 (GN2/1)
				G27		
				G30	971113	
				G31		
	KGPG - 6.41,5.2.01	41,5	1 x 3,5 + 2 x 5,0 + 2 x 7,0 + 1 x 9,0 Piekarnik 5,0	G20	971121	
				G27		
				G30	971123	
			G31			

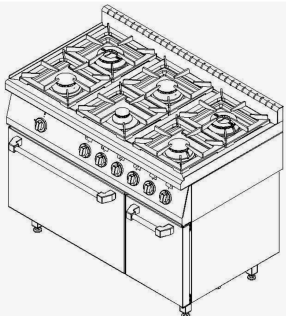
	KGPG - 6.37,5.4.01	37,5	1 x 3,5 + 3 x 5,0 + 2 x 7,0 Piekarnik 5,0	G00		1200 x 750 x 850 Piekarnik 530x650 (GN2/1)
				G27		
				G30		
				G31		
	KGPG - 6.41,5.4.01	41,5	1 x 3,5 + 2 x 5,0 + 2 x 7,0 + 1 x 9,0 Piekarnik 5,0	G20		
				G27		
				G30		
			G31			

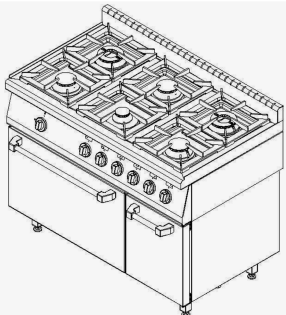
	KGPG - 6.37,5.6.01	37,5	1 x 3,5 + 3 x 5,0 + 2 x 7,0 Piekarnik 5	G20		1200 x 700 x 850 Piekarnik 530x650 (GN2/1)
				G27		
				G30		
				G31		
	KGPG - 6.41,5.6.01	41,5	1 x 3,5 + 2 x 5,0 + 2 x 7,0 + 1 x 9,0 Piekarnik 5	G20		
				G27		
				G30		
				G31		